



Lcdmod Kit

U204FR-A3

USB interface LCD PC modding

20 characters x 4 lines

Red characters with black background

With Black glossy cover

User Manual

Website: <http://www.lcdmodkit.com>

Rev: 1.02 Feb 2017

CHAPTER 1 INTRODUCTION..... 2
CHAPTER 2 HARDWARE SETUP 4
CHAPTER 3 DRIVER INSTALLATION 5
CHAPTER 4 SOFTWARE INSTALLATION 9

Chapter 1 Introduction

1.1 Package Contents



1.2 Specifiaction

Data Transfer	USB 1.1 compliant
LCD Resolution	20 Characters x 4 Lines
LCD color	Red characters / Black background
Screen Size	76 x 26 mm
Frame Size	5 1/4" bay drive
Work with	Lcd Smartie
Opearting System	Windows 98, XP, 7 32 & 64 bits
USB connection	Internal USB cable for mother board
USB ID	VID : 0403, PID: C630

Note: Computer cannot control more than one USB LCD with same USB VID/PID pairs at the same time. It only will communicate one of them only. If you want to control more than one USB LCD by a computer, you must make sure that its USB VID/PID pair are not same. We have provide different USB VID/PID pair USB LCD, please see the specification of them.

1.3 Lcd Screen drawing

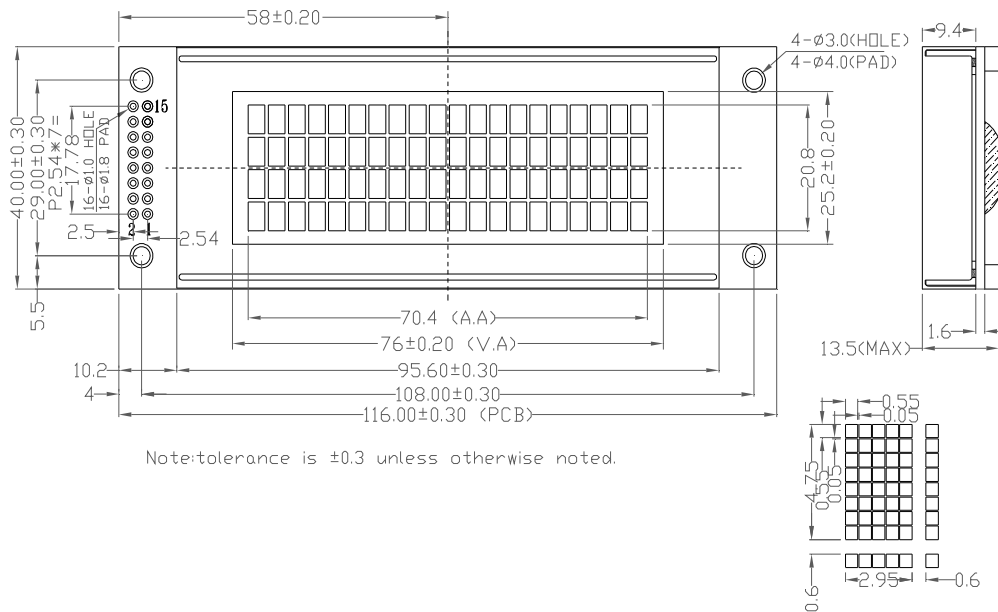

Chapter 2 Hardware Setup

2.1 Install it on bay drive



2.2 Connecting internal USB cable of Motherboard port side





(D- = USBP*- , D+ = USBP**+)

USB-Pin Definition

PIN	Assignment	PIN	Assignment
1	VCC	6	USBP1+
2	VCC	7	GND
3	USBP0-	8	GND
4	USBP1-	9	KEY
5	USBP0+	10	OC#

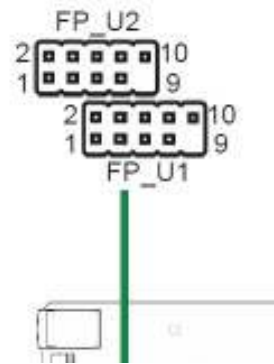

Chapter 3 Driver Installation

3.1 Power up message will be shown on the LCD screen when computer power on.

3.2 Skip obtaining driver software from Windows Update

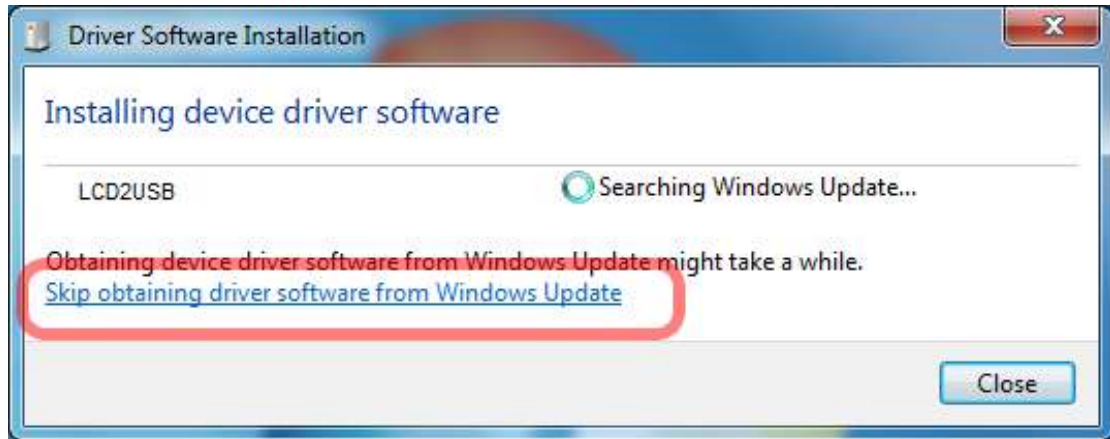

3.3 Message show up driver software was not successfully installed

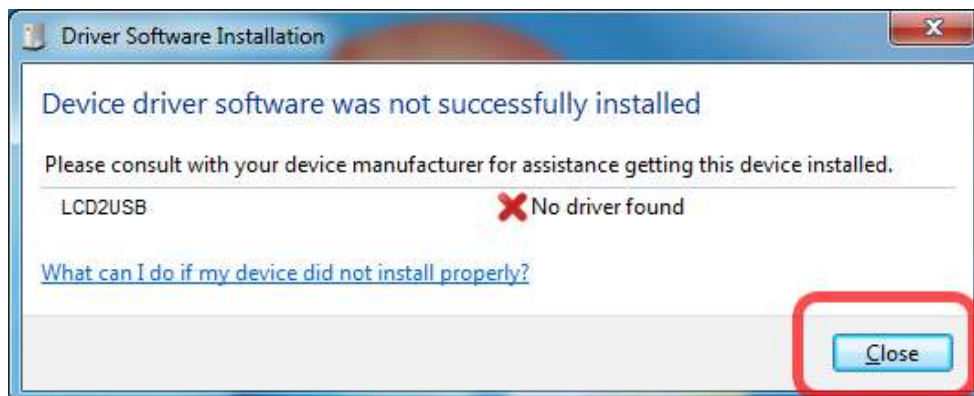

3.4 Find out the zadig driver installation program in our software packs in our web site.



3.5 Run the zadig.exe as administrator (Windows XP users, please run the zadig.exe XP version)

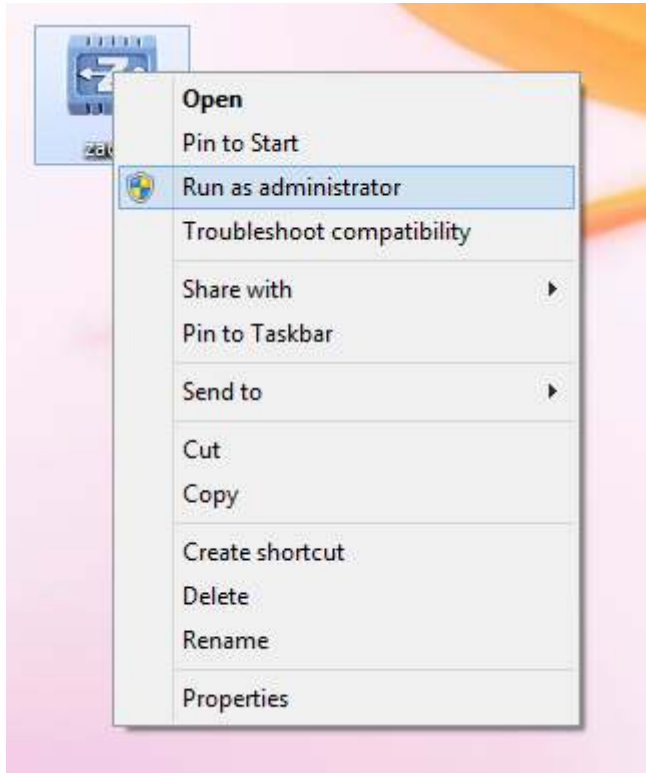

3.6 In "Options", tick "List All Devices"

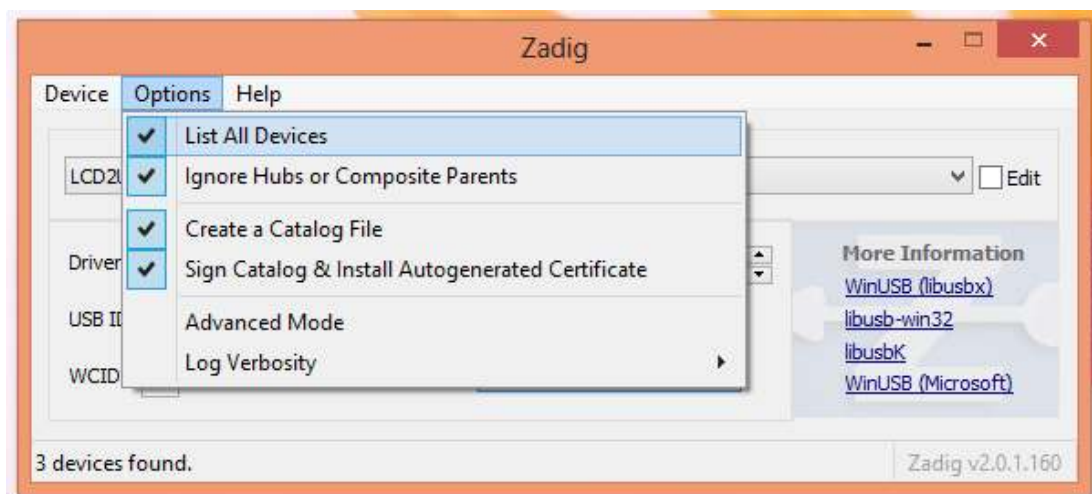

3.7 Select "LCD2USB" device and then select the "libusb-win32" or "libusbK" driver

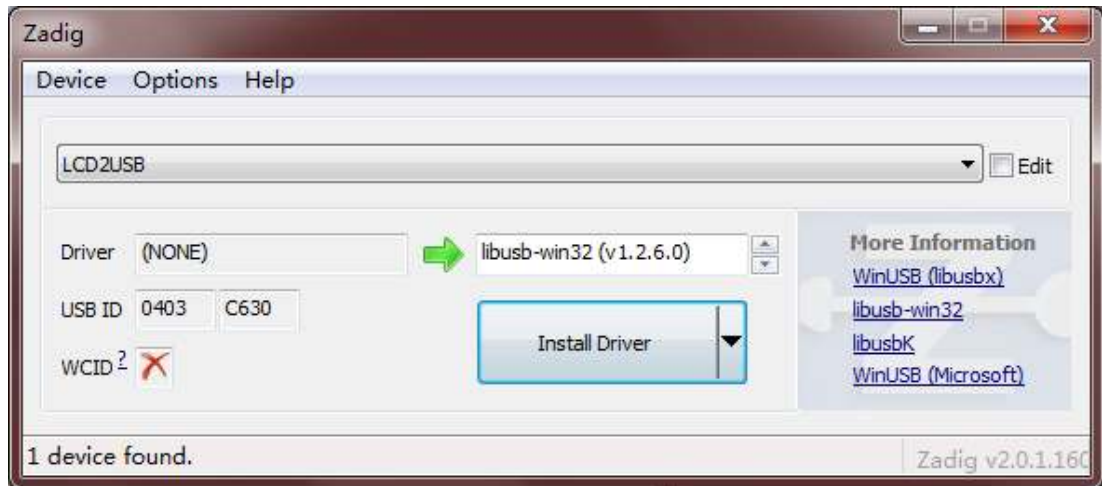

3.8 Click "Install Driver"/"Replace Driver"/"Reinstall Driver" button

3.9 Install this driver software anyway

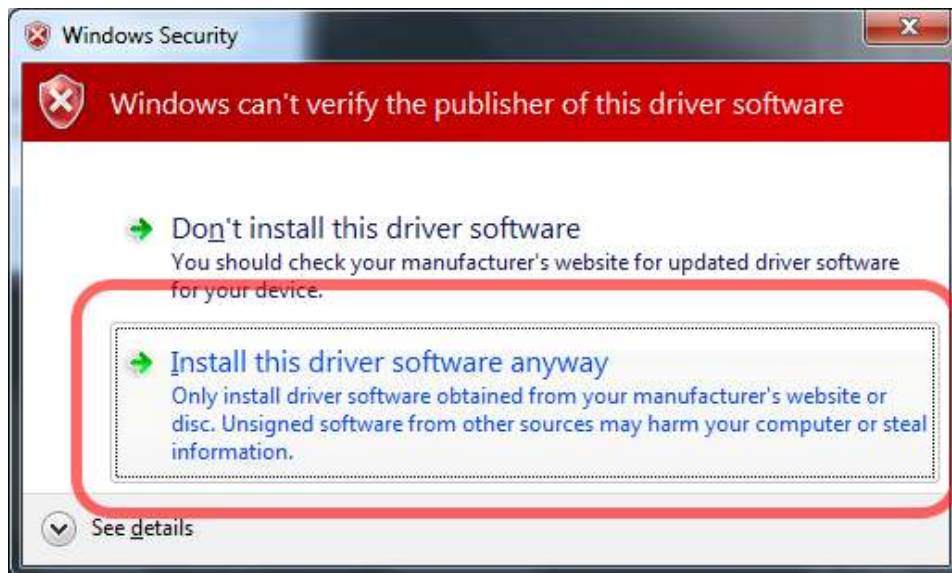

3.10

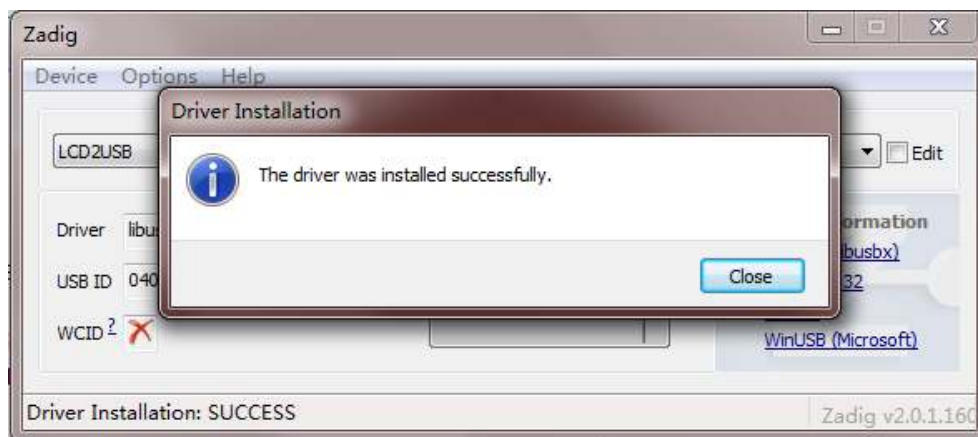

Chapter 4 Software Installation

4.1 Unzip the “lcd_smartie_v5.4” to any drive any folder you like.

4.2 Unzip the “LCD2USB-smartie.zip” to any drive any folder you like.

4.3 Copy the LCD2USB.dll to the displays folder.



4.4 Run “LCDSmartie”



4.5 Set the display plugin in setup

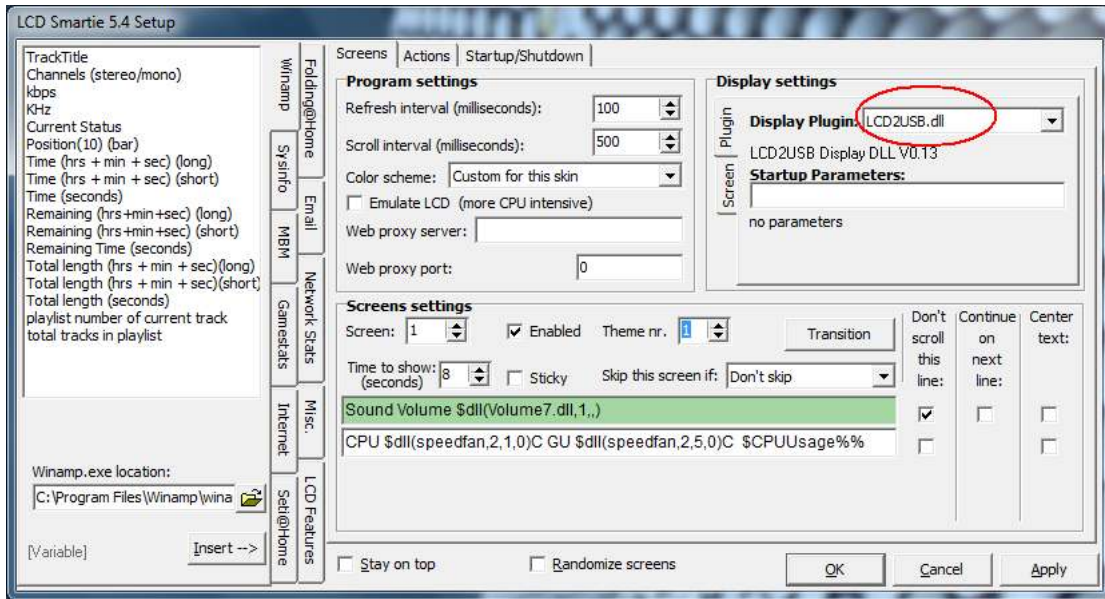

4.6 Change the LCD size to “2x16” and tune the LCD contrast and brightness of backlight

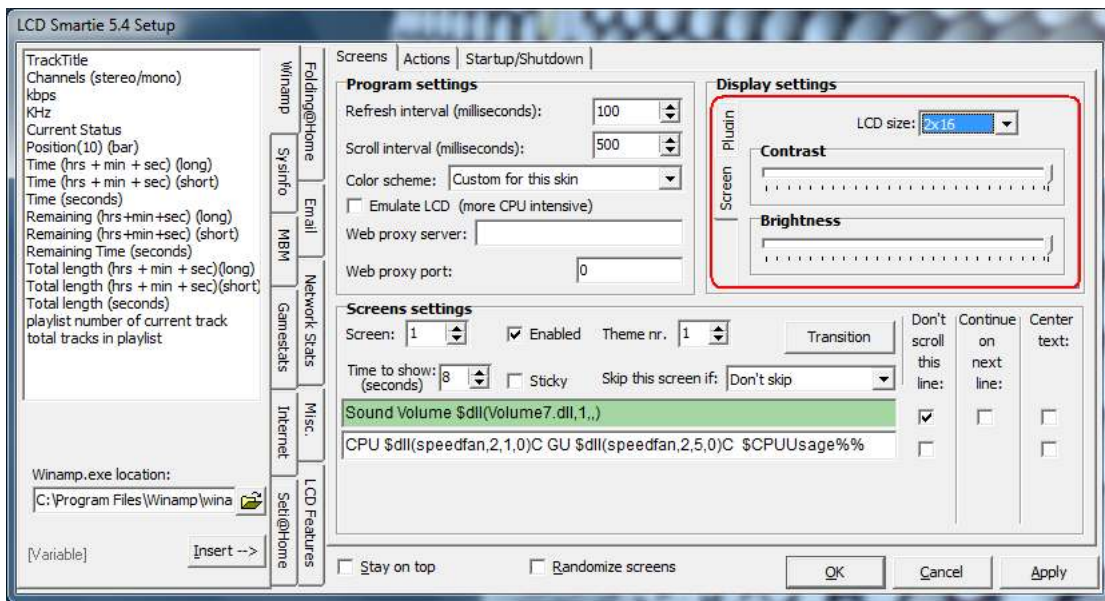

Note: For more details about LCDSmartie, please go through the official site of LCDSmartie <http://lcdsmartie.sourceforge.net/>

